

***ROADWAY DESIGN
PLAN DEVELOPMENT
GUIDELINES***



**PREPARED BY
ARKANSAS DEPARTMENT OF TRANSPORTATION
ROADWAY DESIGN DIVISION**

TABLE OF CONTENTS

DATE: 09-16-20

	TITLE	PAGE NUMBER	DATE
SECTION 1	PLAN ASSEMBLY	1-1	10-11-17
SECTION 2	TITLE SHEET	2-1	08-01-02
SECTION 3	GENERAL NOTES	3-1 3-2	02-19-19 11-05-18
SECTION 4	TYPICAL SECTIONS	4-1 4-2	11-07-19 09-16-20
SECTION 5	SPECIAL DETAILS	5-1 5-2 5-3 5-4 5-5 5-6 5-7 5-8 5-9 5-10 5-11 5-12 5-13	04-01-05 04-01-05 03-20-03 05-01-98 05-01-98 05-01-98 05-01-98 08-01-02 08-01-02 08-01-02 03-20-03 05-01-98 05-01-98
SECTION 6	QUANTITY SHEETS	6-1 6-2 6-3	09-12-14 04-01-05 05-01-98
SECTION 7	SUMMARY OF QUANTITIES	7-1	09-12-14
SECTION 8	PLAN AND PROFILE SHEETS	8-1 8-2	10-24-97 12-30-96
SECTION 9	CROSS SECTIONS	9-1	10-24-97

APPENDIX

DATE: 04-08-20

	TITLE	PAGE NUMBER	DATE
APPENDIX A	PAVEMENT DESIGN CRITERIA	A-1 A-2 A-3 A-4 A-5	05-01-98 05-10-06 05-10-06 05-30-19 05-30-19
APPENDIX B	CLEAR ZONE REQUIREMENTS	B-1	12-30-96
APPENDIX C	ACCESS CONTROL DESIGN CRITERIA	C-1 C-2	12-07-17 12-07-17
APPENDIX D	CULVERT SELECTION CRITERIA	D-1 D-2 D-3	11-07-19 11-07-19 01-01-11
APPENDIX E	GUARDRAIL CRITERIA	E-1	09-05-18
APPENDIX F	TRAFFIC CONTROL CRITERIA	F-1 F-2 F-3	07-25-19 07-25-19 10-25-18
APPENDIX G	PLAN REVIEW AND COORDINATION	G-1	12-30-96
APPENDIX H	DESIGN CHECKLIST	H-1 H-2	05-01-98 05-01-98
APPENDIX I	CONSULTANT PLAN SUBMITTALS	I-1	08-01-02
APPENDIX J	INTERCHANGE DESIGN INTERCHANGE LOOP RAMPS INTERCHANGE ACCEL. LANES	J-1 J-2 J-3	07-23-07 07-30-07 07-30-07
APPENDIX K	GUIDELINES FOR PASSING LANE DESIGN	K-1 K-2	10-25-18 10-25-18

SECTION 1
PLAN ASSEMBLY

DATE: 10-11-17

The following sequence should be used as a general guide when assembling plans:

1. Title Sheet
2. Index of Sheets, Bridge Standard Drawings, and Roadway Standard Drawings
3. Governing Specifications, General Notes, and Legend
4. Typical Sections of Improvement
 - a) Main Lane Typical
 - b) Cross Roads, Frontage Roads, and Ramp Typical
 - c) Detour Typical
5. Special Details
 - a) Driveway, County Roads, Guardrail Widening and Pipe Underdrains
 - b) Stage Construction
 - c) Box Culvert Details
 - d) At-Grade Intersection Layouts
 - e) Temporary Erosion Control Details
 - f) Other Details
6. Maintenance of Traffic Details
7. Permanent Pavement Marking Details
8. Quantity Sheets
9. Summary of Bridge Quantities
10. Summary of Quantities and Revision Box
11. Survey Control Details
12. Main Lane Plan and Profile Sheets
13. Interchange Layout Sheets
14. Ramp Profile Sheets
15. Detour or Stage Construction Plan and Profile Sheets
16. Cross Roads Plan and Profile Sheets
17. Signalization Plans
18. Permanent Signing Plans
19. Illumination Quantities and Layout Sheets
20. Culvert Diagrams
21. Bridge Plans
22. Cross Section Sheets
23. Bridge Standard Drawings (Do not add page numbers for these sheets.)
24. Roadway Standard Drawings (Do not add page numbers for these sheets.)

SECTION 2
TITLE SHEET

DATE: 08-01-02

The Title Sheet should generally include, but not be limited to, the following information:

1. Job Title and Job Number from Staff Minutes.
2. County, Route, Section.
3. Federal Aid Project Number, if applicable.
4. North Point.
5. Sketch Map to Scale showing beginning and ending stations.
6. Note Describing "THIS IS A FULLY CONTROLLED ACCESS FACILITY", if applicable.
7. Log Mile Reference on English projects.
8. Notes for Structures over 20' (6.0m) Span.
9. Equations and any Exceptions to Project.
10. Metric Logo in Lower Right Hand Corner for Metric Projects.
11. Place "THIS IS A METRIC JOB" Above Sketch Map for Metric Projects.
12. Length of Project - Separate by Funding Changes.
13. Township, Range, and Section.
14. Vicinity Map in upper left corner showing Project Location.
15. State Map showing Current Districts with County Hatched.
16. Current Design Data. Show "Average Running Speed" for 3R projects in lieu of Design Speed.
17. Mid-Point of Project designating Latitude and Longitude.
18. PE Job Number.
19. Chief Engineer's PE Stamp.

SECTION 3

GENERAL NOTES

DATE: 02-19-19

The list of General Notes should generally include, but not be limited to, the following notes. The entire list of notes should be reviewed by the Designer and only those notes that pertain to each individual project should be used.

1. GRADE LINE DENOTES FINISHED GRADE WHERE SHOWN ON PLANS.
2. ALL PIPE LINES, POWER, TELEPHONE, AND TELEGRAPH LINES TO BE MOVED OR LOWERED BY THE RESPECTIVE OWNERS AS PER AGREEMENT WITH SUCH OWNERS.
3. ANY EQUIPMENT OR APPURTENANCE THAT INTERFERES WITH THE PROPOSED CONSTRUCTION AND WHICH MAY BE THE PROPERTY OF UTILITY SERVICE ORGANIZATIONS SHALL BE MOVED BY THE OWNERS UNLESS OTHERWISE PROVIDED.
4. THE CONTRACTOR SHALL BE RESPONSIBLE FOR MAINTAINING U.S. MAILBOXES WITHIN THE PROJECT LIMITS IN SUCH A MANNER THAT THE PUBLIC MAY RECEIVE CONTINUED MAIL SERVICE. PAYMENT WILL BE CONSIDERED INCLUDED IN THE PRICE BID FOR THE VARIOUS BID ITEMS.
5. ALL LAND MONUMENTS LOCATED WITHIN THE CONSTRUCTION AREA SHALL BE PROTECTED IN ACCORDANCE WITH SECTION 107.12 OF THE STANDARD SPECIFICATIONS.
6. ALL TREES THAT DO NOT DIRECTLY INTERFERE WITH THE PROPOSED CONSTRUCTION SHALL BE SPARED AS DIRECTED BY THE ENGINEER. CARE AND DISCRETION SHALL BE USED TO ENSURE THAT ALL TREES NOT TO BE REMOVED SHALL BE HARMED AS LITTLE AS POSSIBLE DURING THE CONSTRUCTION OPERATIONS.
7. THE CONTRACTOR SHALL BE RESPONSIBLE FOR PROVIDING A FENCE TO CONTROL LIVESTOCK IN AREAS WHERE PASTURES ARE SEVERED. WIRE FENCE MAY BE CONSTRUCTED INITIALLY, OR IN LIEU THEREOF, THE CONTRACTOR, AT HIS OWN EXPENSE, MAY ELECT TO PROVIDE TEMPORARY FENCING SUITABLE TO CONTAIN LIVESTOCK.
8. THE SEQUENCE AS SHOWN ON THE MAINTENANCE OF TRAFFIC PLANS IS A GENERAL OUTLINE FOR THE CONSTRUCTION OF THIS PROJECT, AND IN NO WAY IS IT INTENDED TO COVER EVERY ITEM IN THE PROJECT. ITEMS NOT CRITICAL TO THE CONSTRUCTION SEQUENCE MAY BE CONSTRUCTED IN ANY STAGE AS APPROVED BY THE RESIDENT ENGINEER.
9. ALL FLEXIBLE BASE AND ASPHALTIC PAVEMENTS REMOVED SHALL BE PAID FOR UNDER THE ITEM NO. 210 – UNCLASSIFIED EXCAVATION.

SECTION 3
GENERAL NOTES

DATE: 11-05-18

10. THE EXISTING ASPHALT PAVEMENT TO BE REMOVED FROM THE REMAINING PAVEMENT SHALL BE SEPARATED BY SAWING ALONG A NEAT LINE. AFTER SAWING, THE PAVEMENT TO BE REMOVED SHALL BE CAREFULLY REMOVED IN A MANNER THAT WILL NOT DAMAGE THE PAVEMENT THAT IS TO REMAIN. ANY DAMAGE OF THE ASPHALT PAVEMENT THAT IS TO REMAIN IN PLACE SHALL BE REPAIRED AT THE CONTRACTOR'S EXPENSE.

11. A) THIS PROJECT IS COVERED UNDER A NATIONWIDE 14 SECTION 404 PERMIT. REFER TO SECTION 110 OF THE STANDARD SPECIFICATIONS, EDITION OF 2014, FOR PERMIT REQUIREMENTS.

B) THIS PROJECT IS COVERED UNDER A NATIONWIDE 23 SECTION 404 PERMIT. REFER TO SECTION 110 OF THE STANDARD SPECIFICATIONS, EDITION OF 2014, FOR PERMIT REQUIREMENTS.

C) THIS PROJECT IS COVERED UNDER A NATIONWIDE 26 SECTION 404 PERMIT. REFER TO SECTION 110 OF THE STANDARD SPECIFICATIONS, EDITION OF 2014, FOR PERMIT REQUIREMENTS.

SECTION 4

TYPICAL SECTIONS

DATE: 11-07-19

The Typical Sections of Improvement should generally include, but not be limited to, the following information:

1. Slope note which states "REFER TO CROSS SECTIONS FOR DEVIATION FROM THE NORMAL SLOPES. NO CHANGES SHALL BE MADE FROM THE PLANNED SLOPES WITHOUT THE APPROVAL OF THE ENGINEER".
2. Tolerance notes for thickness of aggregate base course if being used under the main lanes with a specified compacted depth. Tolerance note as follows: "THE THICKNESS OF AGGREGATE BASE COURSE SHALL BE WITHIN PLUS OR MINUS ONE INCH (25mm) OF THE PLAN THICKNESS SHOWN. THE CONTRACTOR WILL CORRECT ANY DEFICIENT THICKNESS THAT DOES NOT MEET TOLERANCE INDICATED. PAYMENT WILL NOT BE MADE FOR MATERIAL PLACED IN EXCESS OF THE TOLERANCE INDICATED". Do not use this note for detours or for aggregate base under shoulders. Use "Variable Compacted Depth" under shoulders.
3. Leveling note if overlaying an existing highway and providing a quantity of asphalt for leveling. Leveling note as follows: ASPHALT FOR LEVELING OF EXISTING PAVEMENT SHALL BE PLACED ONLY IF AND WHERE DIRECTED BY THE ENGINEER. CALCULATIONS FOR THE AMOUNT OF LEVELING AND LEVELING OPERATIONS SHALL BE PERFORMED BEFORE CONSTRUCTING NOTCH AND WIDENING. CALCULATIONS WILL NOT BE PAID FOR DIRECTLY, BUT WILL BE CONSIDERED INCLUDED IN THE VARIOUS PAY ITEMS.
4. Tolerance note for subgrades if constructing a grading and structures type project that will include surfacing in a later contract. Tolerance note as follows: IT IS INTENDED THAT THE SUBGRADE SHALL BE FINISHED IN CONFORMITY WITH THE LINES, GRADES, AND CROSS SECTIONS SHOWN ON THE PLANS. HOWEVER, A TOLERANCE OF PLUS OR MINUS ONE-TENTH FOOT (30mm) WILL BE ALLOWED.
5. Subgrade Width
6. Clear Zones: Dimension from outside travel lanes according to design speed and ADT, but DO NOT USE WORDS "CLEAR ZONE" with dimension. Use same clear zone widths for cut and fill side. It is permissible, on 3R Projects, to use different clear zones for cut and fill.
7. Side Slopes: Use run to rise for English slopes and rise to run for metric slopes. Cross slopes for finished grade and for subgrade: Use ft./ft. for English cross slopes and percents for metric cross slopes.
8. Dimension all asphalt layers in order they are to be placed on roadway.
9. Travel lane, left turn lane, median, auxiliary lane, and shoulder widths. Existing roadway width if an overlay project.
10. Depth of notch for overlay project.
11. Point of profile grade application, if applicable.
12. Minimum overlay thickness required for overlay projects.

SECTION 4
TYPICAL SECTIONS

DATE: 09-16-20

13. Superelevation typicals with point of rotation defined. On most overlay projects, this point would also be the control point for overlay thickness depending on the existing pavement width.
14. Pipe underdrains usually located at edge of travel lane for projects using Aggregate Base Course (Class 5) under shoulders and where notching on high side of shoulders in Superelevation.
15. Extend main lane pavement structure 2' (0.6m) into shoulders for freeways and principle arterial routes. On four lane divided highways, extend 2' (0.6m) into outside shoulder only.
16. Metric Logo in lower right hand corner for metric projects.
17. When using stage construction and overlay is to be constructed such that stage construction will be carried on the first lift of surface and the final surface course will be laid prior to final striping, this note should be used if using 1/2" or 12.5mm surface: THE FINAL 2" (50mm) OF SURFACE COURSE IS TO BE PLACED AFTER ALL OTHER COURSES HAVE BEEN LAID. LONGITUDINAL JOINTS SHALL BE AT LANE LINES.
18. When using stage construction and overlay is to be constructed such that stage construction will be carried on the first lift of surface and the final surface course will be laid prior to final striping, this note should be used if using 3/8" or 9.5mm surface: THE FINAL 1 1/2" (38mm) OF SURFACE COURSE IS TO BE PLACED AFTER ALL OTHER COURSES HAVE BEEN LAID. LONGITUDINAL JOINTS SHALL BE AT LANE LINES.
19. Drainage note if C.C.C&G. is to be constructed. Drainage note as follows: PRIOR TO AND DURING PLACEMENT OF PAVEMENT IN FRONT OF THE CURB AND GUTTER, THE CONTRACTOR SHALL PROVIDE POSITIVE DRAINAGE AT ALL TIMES. THE METHOD(S) USED SHALL BE APPROVED BY THE ENGINEER. PAYMENT FOR THIS WORK SHALL BE CONSIDERED INCLUDED IN THE PRICE BID FOR THE VARIOUS CONTRACT ITEMS.
20. Drainage note if notching and widening existing roadway. Drainage note as follows: BLEEDER DITCHES – PRIOR TO AND DURING PLACEMENT OF PAVEMENT AT THE NOTCH, THE CONTRACTOR SHALL PROVIDE POSITIVE DRAINAGE AT ALL TIMES. THE METHOD(S) AND SPACING USED SHALL BE APPROVED BY THE ENGINEER. PAYMENT FOR THIS WORK SHALL BE CONSIDERED INCLUDED IN THE PRICE BID FOR THE VARIOUS CONTRACT ITEMS.

SECTION 5
SPECIAL DETAILS

DATE: 04-01-05

Special Details should be job specific and generally include, but not be limited to, the following information:

1. Metric Logo in lower right corner for metric projects.
2. Driveway and Approach Details (attached).
3. Guardrail Widening Detail (attached).
4. Box Culvert Details not shown on Standard Drawings.
5. Bridge End Treatment Detail (attached).
6. Approach Slab Detail (attached).
7. Single Slope Barrier (attached).
8. New Jersey Barrier (attached).
9. Edge Drain Details (attached).
10. Various details for concrete paving (attached).
11. Details for paving concrete shoulders (attached).
12. Details for rumble strips (attached).

SECTION 5

SPECIAL DETAILS

DATE: 04-08-20

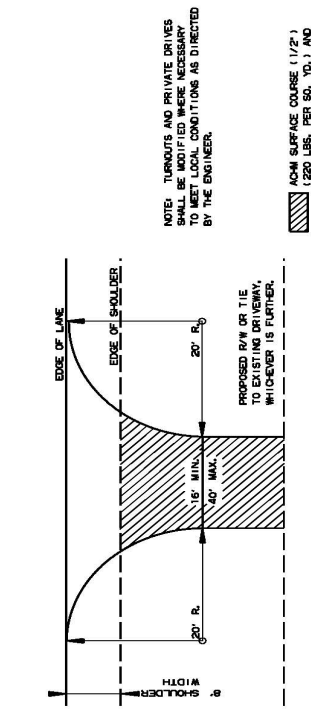

**DETAIL FOR DRIVEWAY TURNOUTS
(ARTERIALS)**

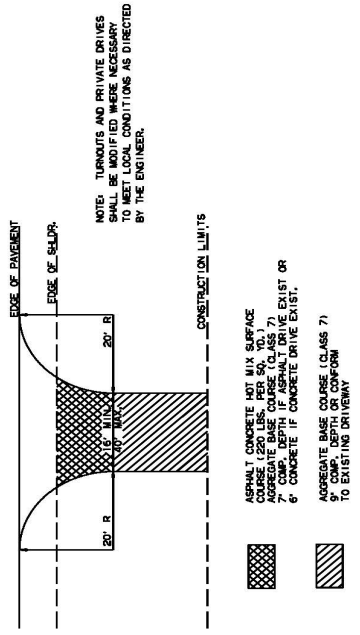

**DETAIL FOR DRIVEWAY TURNOUTS
(COLLECTORS)**

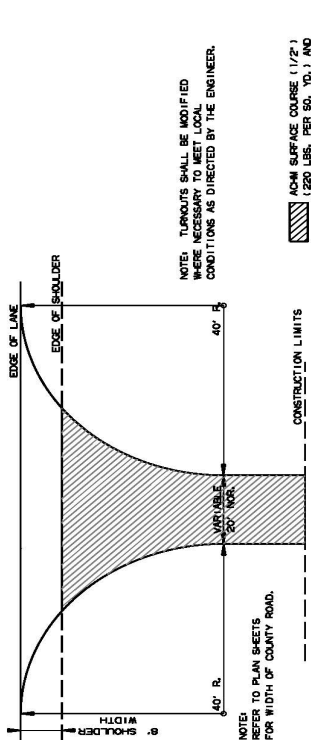

**DETAIL FOR COUNTY ROAD TURNOUTS
(OPEN SHOULDER SECTION)**

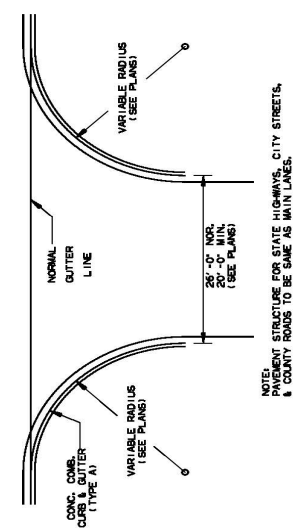

**DETAIL OF TURNOUTS, ASPHALT STREETS,
COUNTY ROADS & STATE HIGHWAYS
CURB & GUTTER SECTION**

SECTION 5 SPECIAL DETAILS

DATE: 03-20-03

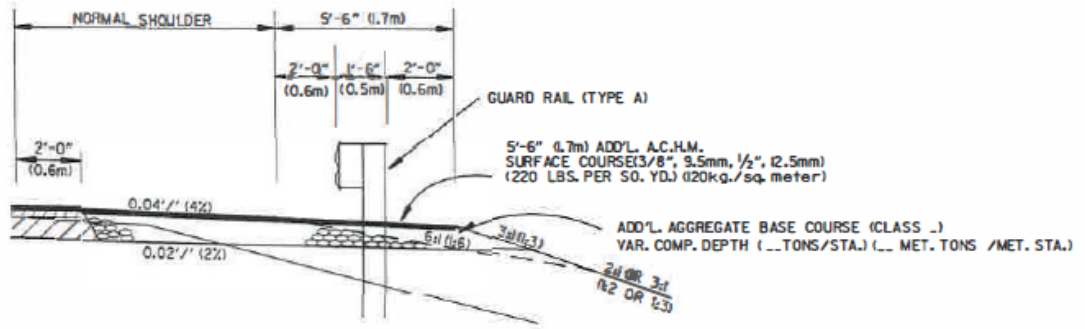

WIDENING FOR GUARD RAIL

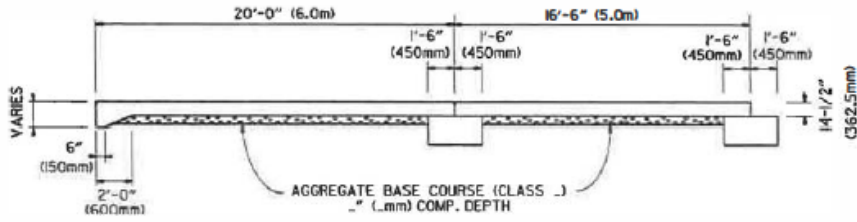

SECTION OF APPROACH SLAB

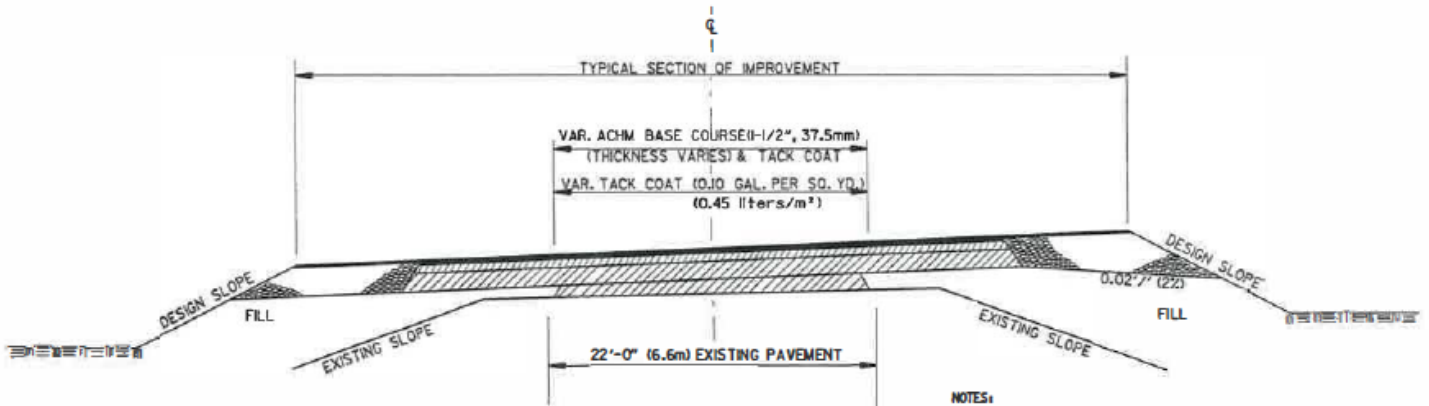

METHOD OF RAISING GRADE

- NOTES:**
- (1) THIS DETAIL TO BE USED ONLY WHERE DIRECTED BY THE ENGINEER.
 - (2) QUANTITIES FOR METHOD OF GRADE RAISE USING ASPHALT WERE CALCULATED ON THIS PROJECT AT LOCATIONS WHERE THE DISTANCE BETWEEN THE EXISTING ASPHALT ROADWAY AND THE PROPOSED SUBGRADE WAS ONE FOOT OR LESS.
 - (3) IN LOCATIONS WHERE THE DISTANCE BETWEEN THE PROPOSED SUBGRADE AND THE EXISTING ASPHALT ROADWAY IS MORE THAN ONE FOOT, SCARIFICATION OF THE EXISTING ASPHALT ROADWAY WILL BE REQUIRED AS STATED IN SECTION 20, SUBSECTION 20.09 OF THE STANDARD SPECIFICATIONS, EDITION OF 2003.

SECTION 5
SPECIAL DETAILS

DATE: 05-01-98

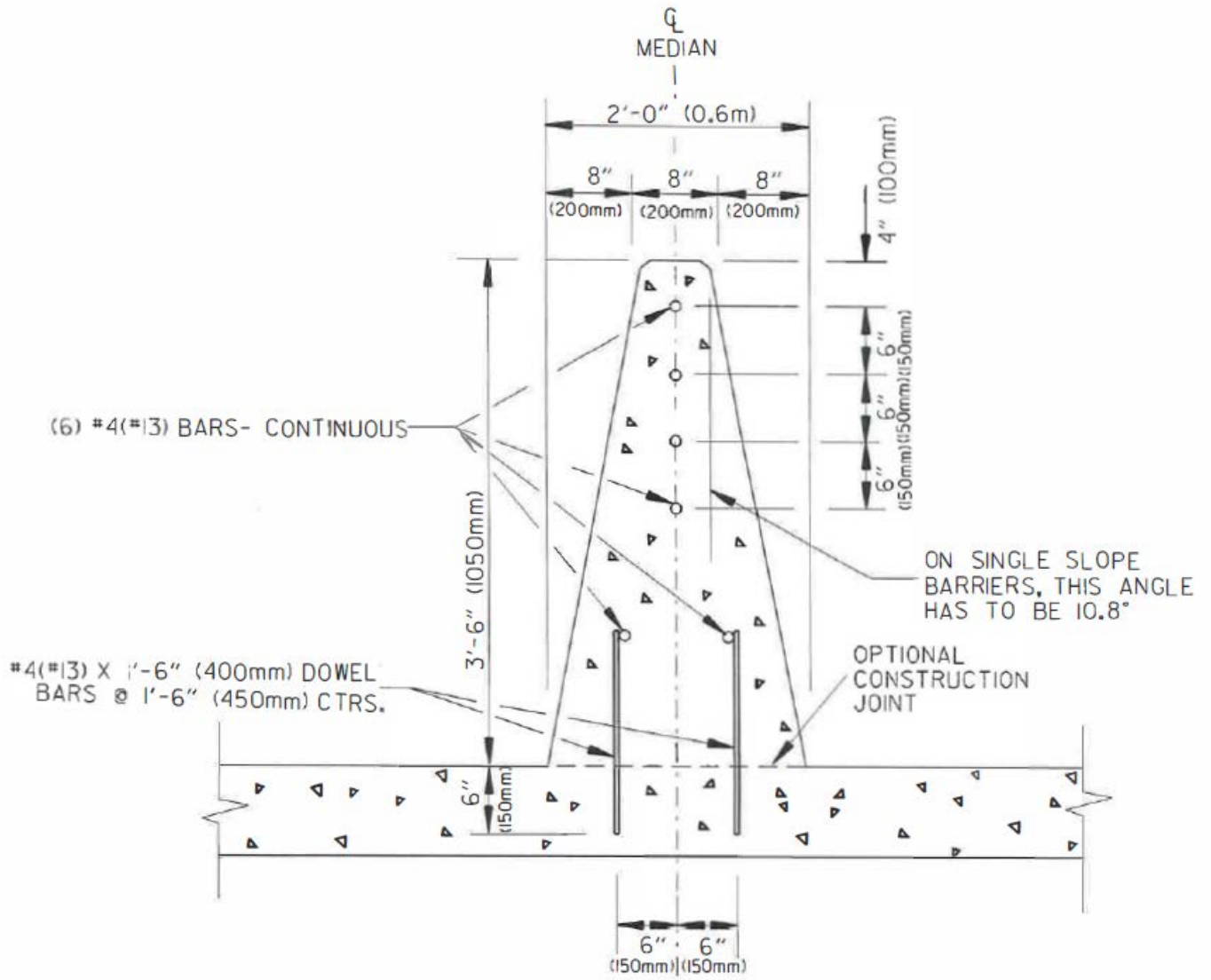

CONCRETE BARRIER WALL

SECTION 5

SPECIAL DETAILS

DATE: 05-01-98



CONTRACTION JOINT DETAIL

GENERAL NOTES FOR CONCRETE BARRIER WALL

1. CONTRACTION JOINTS REQUIRED AT 15'-0" (4.5m) MAX. SPACING.
2. ALL JOINTS TO BE FORMED IN FRESH CONCRETE IN TOP AND SIDES OF BARRIER WALL.
3. DOWEL BARS WILL NOT BE REQUIRED IF BARRIER AND BASE ARE CAST AS A COMPLETE UNIT.
4. ALL EXPOSED EDGES OF THE CONCRETE BARRIER WALL SHALL HAVE A 1/4" (6mm) CHAMFER.

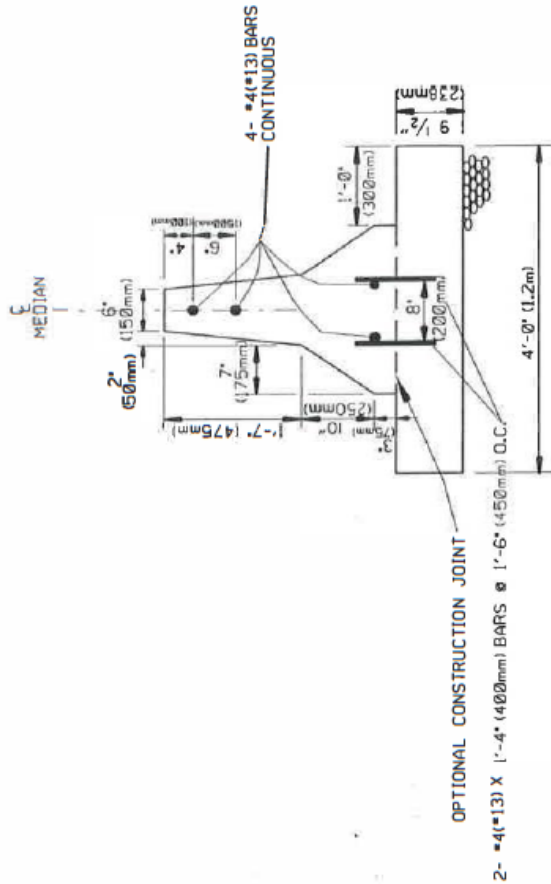

DETAILS OF CONCRETE BARRIER WALL
(MEDIAN TYPE A)

SECTION 5 SPECIAL DETAILS

DATE: 05-01-98

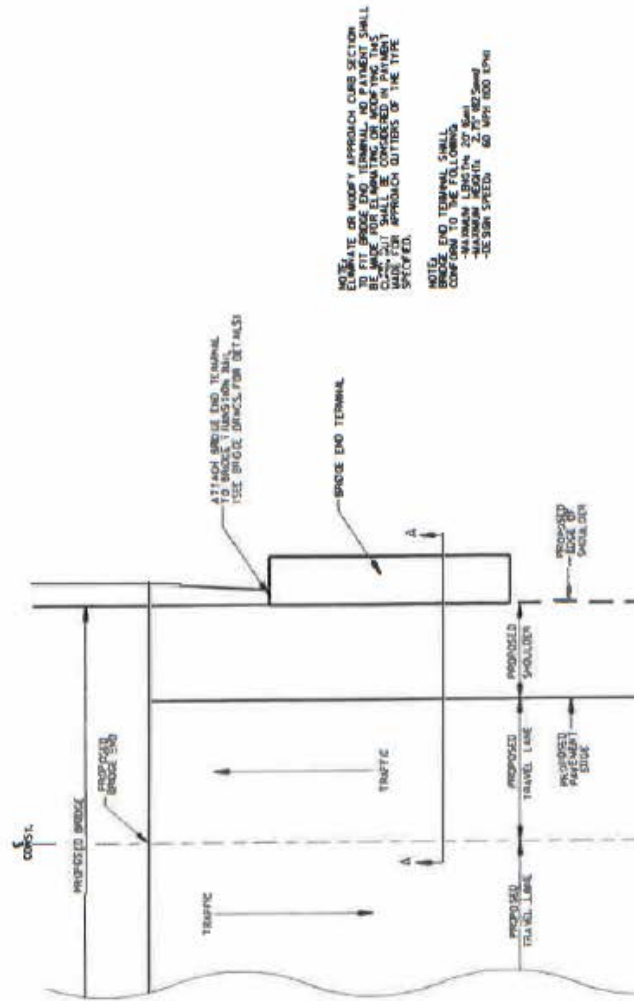

NOTE: ELIMINATE OR MODIFY APPROACH CURB SECTION TO BRIDGE END TERMINAL. THE BRIDGE END TERMINAL SHALL BE MADE FOR ELIMINATING OR MODIFYING THE CURB. THE APPROACH CURB SHALL BE CONSIDERED IN PAYMENT APPROACH WIDTHS OF THE TYPE SPECIFIED.

NOTE: BRIDGE END TERMINAL SHALL CONFORM TO THE FOLLOWING:
 -MINIMUM LENGTH 20' FROM
 -MINIMUM WIDTH 40' FROM
 -DESIGN SPEED 40 MPH 1000 RPM



PLAN VIEW
BRIDGE END TERMINAL
DETAILS

SECTION 5
SPECIAL DETAILS

DATE: 05-01-98



TYPICAL SECTION OF WIDENING FOR GUARD RAIL

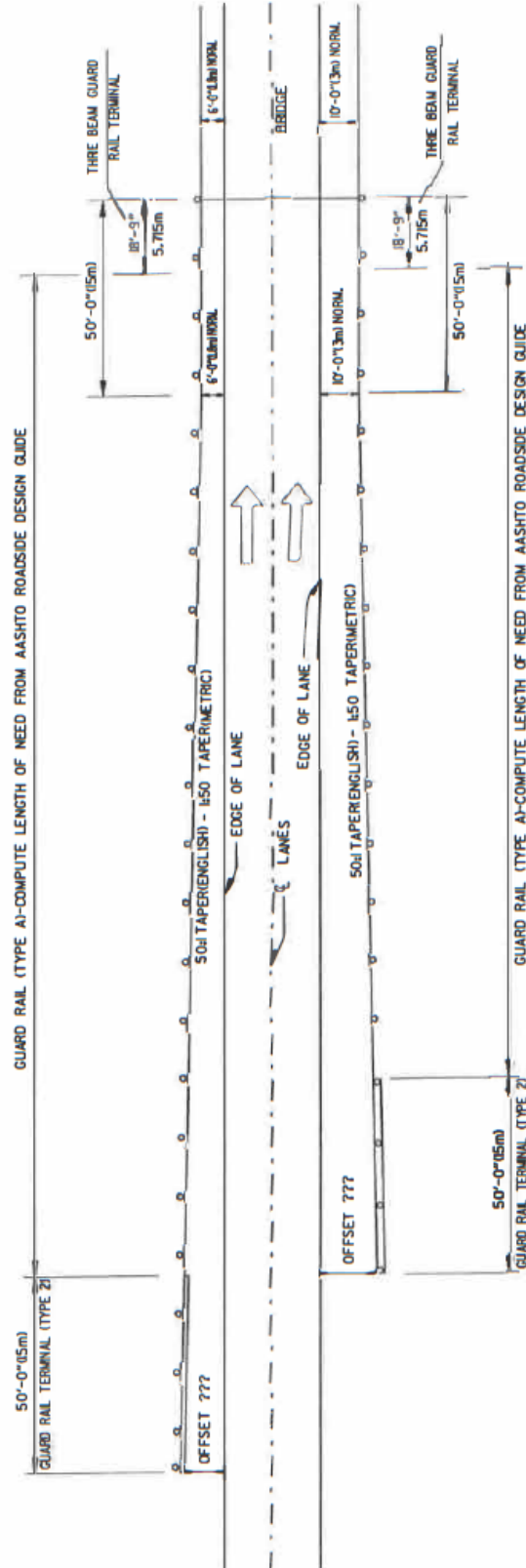

WIDENING FOR GUARD RAIL AT BRIDGE ENDS - 4 LANE DIVIDED

NOTE: REFER TO STANDARD DRAWINGS GR-8, GR-8A, GR-9, GR-10 & GR-10A FOR ADDITIONAL INFORMATION.
NOTE: REFER TO STANDARD DRAWINGS GR-8(M), GR-8A(M), GR-9(M), GR-10(M), & GR-10A(M) FOR ADDITIONAL INFORMATION.

SECTION 5
SPECIAL DETAILS

DATE: 08-01-02

THIS PAGE LEFT BLANK INTENTIONALLY

SECTION 5 SPECIAL DETAILS

DATE: 08-01-02

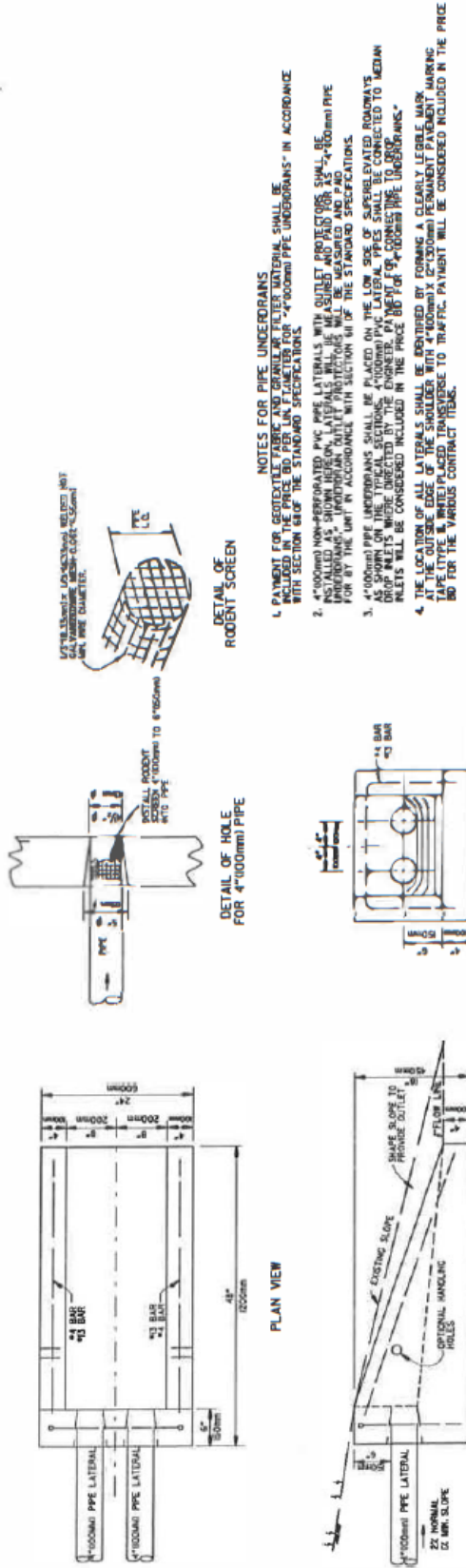

- NOTES FOR PIPE UNDERDRAINS**
- PAYMENT FOR GEOTEXTILE FABRIC AND GRANULAR FILTER MATERIAL SHALL BE IN ACCORDANCE WITH SECTION 620. TYPE I OR TYPE II 4" (100mm) PIPE UNDERDRAINS IN ACCORDANCE WITH SECTION 610 OF THE STANDARD SPECIFICATIONS.
 - 4" (100mm) NON-PERFORATED PVC LATERALS WITH OUTLET PROTECTORS SHALL BE INSTALLED UNDER UNDERDRAINS. UNDERDRAIN OUTLET PROTECTORS WILL BE MEASURED AND PAID FOR BY THE UNIT IN ACCORDANCE WITH SECTION 610 OF THE STANDARD SPECIFICATIONS.
 - 4" (100mm) PIPE UNDERDRAINS SHALL BE PLACED ON THE LOW SIDE OF SUPERELEVATED ROADWAYS AND ON THE HIGH SIDE OF SUPERELEVATED ROADWAYS. UNDERDRAINS SHALL BE CONNECTED TO MEDIAN DRAINAGE DITCHES BY THE ENGINEER. PAYMENT FOR UNDERDRAINS TO DRAINAGE DITCHES WILL BE CONSIDERED INCLUDED IN THE PRICE BID FOR 4" (100mm) PIPE UNDERDRAINS.
 - THE LOCATION OF ALL LATERALS SHALL BE IDENTIFIED BY FORMING A CLEARLY LEGIBLE MARK AT THE OUTSIDE EDGE OF THE SHOULDER WITH 4" (100mm) X 2" (50mm) PERMANENT PAYMENT MARKING TAPE (TYPE II WHITE) PLACED TRANSVERSE TO TRAFFIC. PAYMENT WILL BE CONSIDERED INCLUDED IN THE PRICE BID FOR THE VARIOUS CONTRACT ITEMS.

NOTES: GEOTEXTILE FABRIC SHALL MEET THE REQUIREMENTS OF SECTION 620. TYPE I OR TYPE II 4" (100mm) PIPE UNDERDRAINS AND SIZES OF TRENCH (SEE V).

NOTES: THE LATERALS SHALL MEET THE REQUIREMENTS OF SECTION 620. TYPE I OR TYPE II 4" (100mm) PIPE UNDERDRAINS. UNDERDRAIN OUTLET PROTECTORS SHALL BE INSTALLED ON NEW LATERALS. REFER TO STD. Dwg. IV-1.

SECTION 5 SPECIAL DETAILS

DATE: 03-20-03

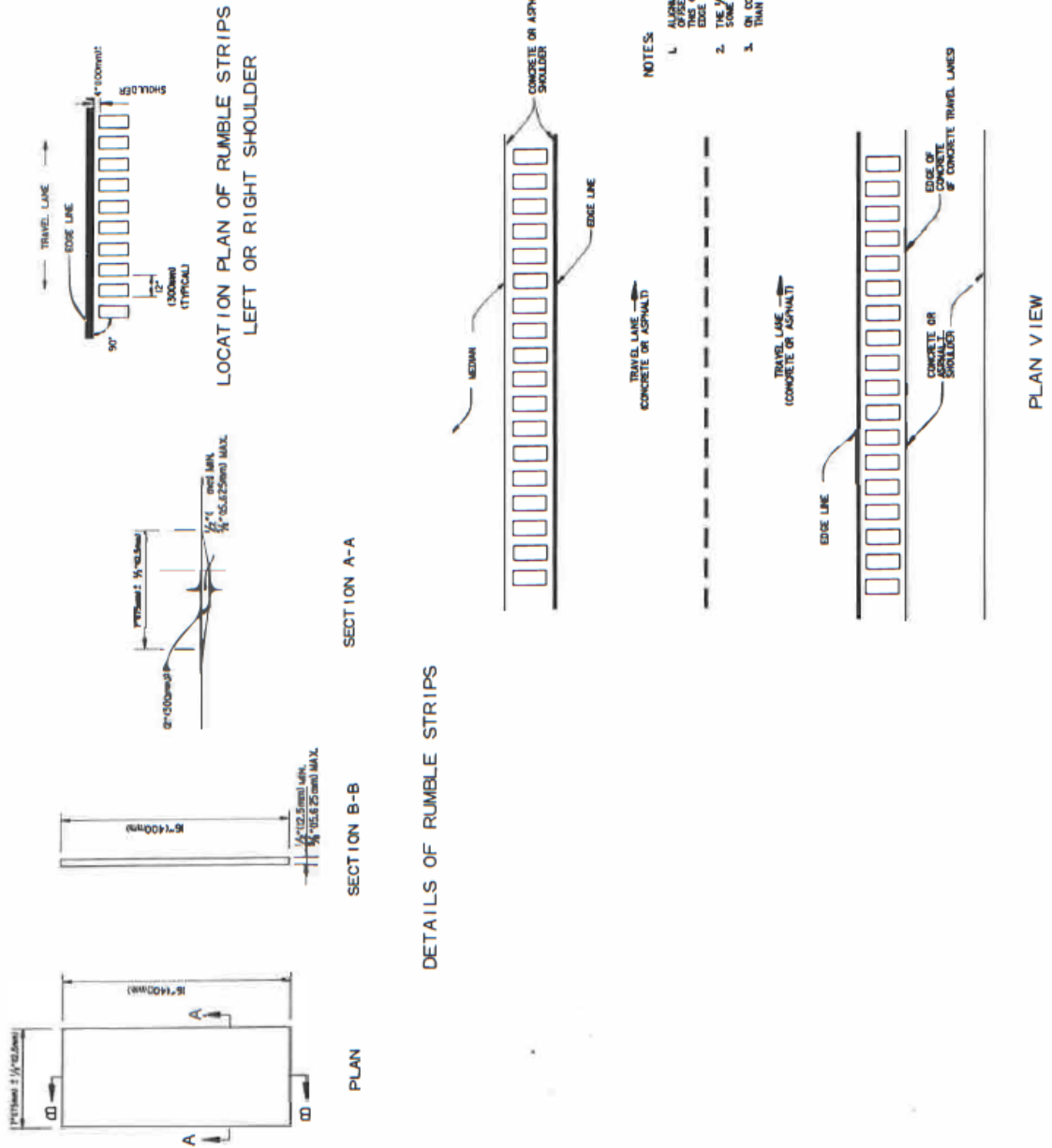

SECTION 5
SPECIAL DETAILS

DATE: 05-01-98

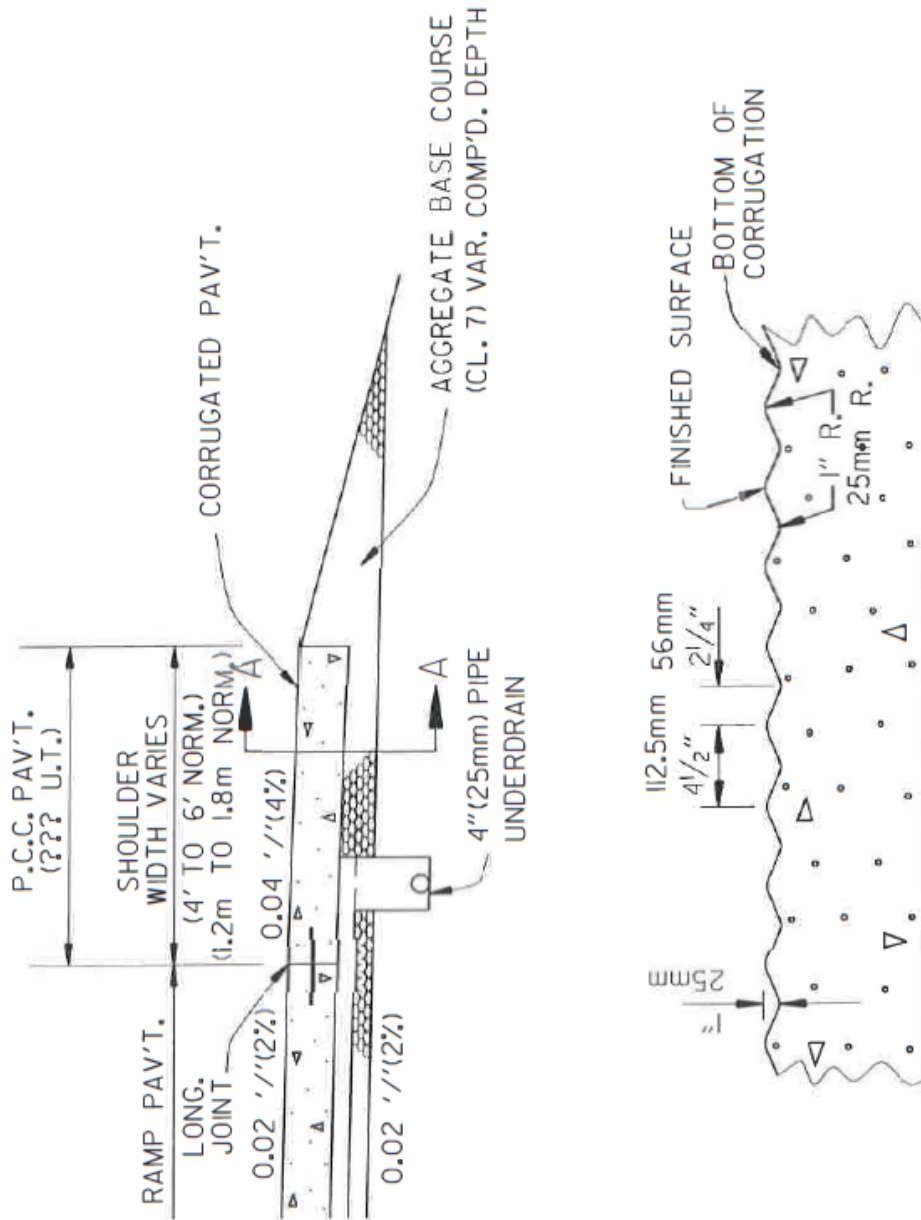

SECTION A-A

CORRUGATED CONCRETE SHOULDER AT RAMP INTERSECTIONS

SECTION 5
SPECIAL DETAILS

DATE: 05-01-98

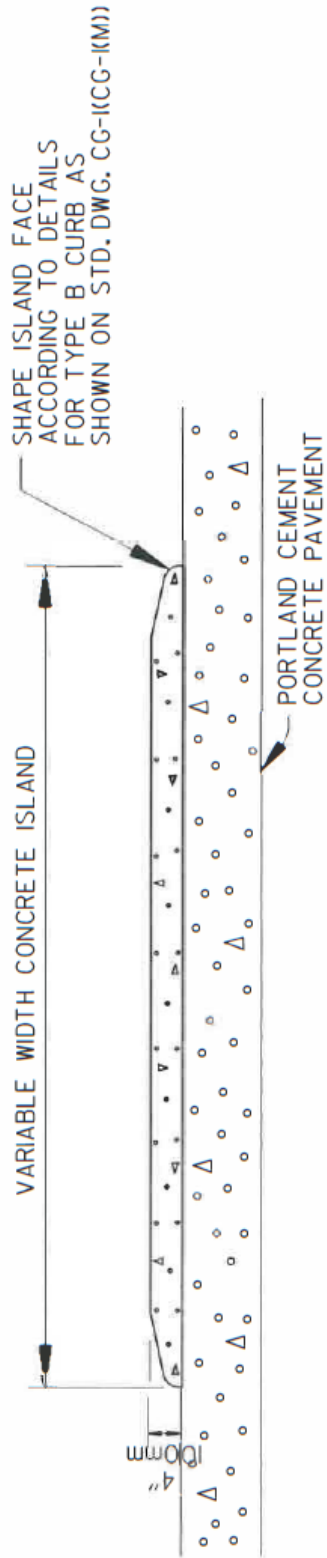

DETAILS OF ISLAND ON P.C. CONCRETE PAVEMENT

SECTION 6

QUANTITY SHEETS

DATE: 09-12-14

The quantity sheets should generally include, but not be limited to, the following notes and "Basis of Estimate". The entire list should be reviewed by the designer and only those notes and "Basis of Estimate" that pertain to each individual project should be used.

1. Note to be used under Soil Log: SOIL CHARACTERISTICS TABULATED ABOVE ARE REPRESENTATIVE AT THE LOCATION OF THE SAMPLE, AND FROM SURFACE INDICATIONS ARE TYPICAL FOR THE LIMITS SHOWN. THESE DATA ARE SHOWN FOR INFORMATION ONLY. THE STATE WILL NOT BE RESPONSIBLE FOR VARIATIONS IN THE SOIL CHARACTERISTICS AND/OR EXTENT OF SAME DIFFERING FROM THE ABOVE TABULATIONS.
2. All quantities that have been estimated should have the note "QUANTITY ESTIMATED" below the quantity box.
3. Notes to be used under the Traffic Control Devices and Pavement Marking box are dependent upon the ADT. A high volume road is defined as current ADT of more than 2000. A low volume road has current ADT of 2000 or less. Notes are as follows:
 - (1) THIS IS A HIGH/LOW VOLUME ROAD AS DEFINED IN SECTION 604.03 OF THE STANDARD SPECIFICATIONS FOR HIGHWAY CONSTRUCTION, EDITION OF 2014.
4. If paying earthwork quantities by plan quantity, place note below earthwork box as follows: EARTHWORK QUANTITIES SHOWN ABOVE SHALL BE PAID AS PLAN QUANTITY.
5. Place the following notes below any quantity box containing the following items:

BASIS OF ESTIMATE:

LIME-----	2 TONS PER ACRE SEEDING
	4.5 METRIC TONS PER HECTARE SEEDING
	102.0 M.G. PER ACRE SEEDING
WATER-----	20.4 M.G. PER ACRE TEMPORARY SEEDING
	940 KILOLITERS PER HECTARE SEEDING
	188 KILOLITERS PER HECTARE TEMPORARY SEEDING
WATER-----	12.6 GALS. PER SQ. YARD SOLID SODDING
	19 LITERS PER SQ. METER SOLID SODDING
	85 SQ. FT.=1 CUBIC YARD
SOD MULCH-----	10.3 SQ. METERS=1 CUBIC METER

SECTION 6
QUANTITY SHEETS

DATE: 04-01-05

6. Place the following note below the Temporary Erosion Control Box:

TEMPORARY EROSION CONTROL DEVICES SHOWN ABOVE AND ON THE PLANS SHALL BE INSTALLED IN SUCH A SEQUENCE AS TO DETER EROSION AND SEDIMENTATION OF U.S. WATERWAYS AS EXPLAINED BY THE NATIONAL POLLUTANT DISCHARGE ELIMINATION SYSTEM PERMIT.

7. Place the following note below the Structures Box:

FOR R.C. PIPE CULVERT INSTALLATIONS, USE TYPE 3 BEDDING UNLESS OTHERWISE SPECIFIED.

FOR C.M. PIPE CULVERT INSTALLATIONS, USE TYPE 2 BEDDING, UNLESS OTHERWISE SPECIFIED.

8. Place asphalt volume controls, as obtained from the Materials Division, for mineral aggregate and asphalt binder under quantity boxes that contain any surfacing and base quantities.

The following rates should be used for asphalt:

110 LBS. PER SQ. YD. PER INCH DEPTH

60 KILOGRAMS PER SQ. METER PER 25 MILLIMETER DEPTH

Place rates of application for asphalt either in the box or below the box.

9. Use the following rates for asphalt surface treatment:

	<u>First Application</u>	<u>Second Application</u>
MINERAL AGGREGATE	22 LBS./SQ. YD.	22 LBS./SQ. YD.
ASPHALT	0.3 GAL./SQ. YD.	0.4 GAL. SQ. YD.

10. Use the following rates for prime and tack coat:

PRIME COAT-----	0.40 GAL. PER SQ. YD. 1.80 LITERS PER SQ. METER
TACK COAT-----	0.03 GAL. PER SQ. YD. 0.14 LITERS PER SQ. METER
TACK COAT-----	0.10 GAL. PER SQ. YD. 0.45 LITERS PER SQ. METER

11. For estimating purposes, the following rates should generally be used for asphalt patching:

ASPHALT CONCRETE PATCHING FOR	25 TONS PER MILE
MAINTENANCE OF TRAFFIC-----	14 METRIC TONS PER KILOMETER
	50 GAL. PER MILE
TACK COAT-----	118 LITERS PER KILOMETER

SECTION 6
QUANTITY SHEETS

DATE: 05-01-98

12. The maximum number of gyrations (Nmax) should be placed under all quantity boxes that contain asphalt quantities.
13. The following estimate should be used when converting aggregate base from cubic yards to tons:

2.1 TONS PER CU. YD. (Estimated 1.4 tons/cu. Yd. with 50% compaction)

2.5 METRIC TONS PER CU. METER (Estimated 1.66 metric tons/cu. meter with 50% compaction)
14. The estimate for Stone Backfill should be coordinated with District personnel at the time of the field inspection.
15. Provide a quantity of material in the plans for Selected Pipe Bedding and Selected Pipe Backfill. Designate these materials to be used as directed by the Engineer unless specific locations need to be specified.
16. Provide a quantity of unclassified excavation in the plans for channel change for box culverts as required by Standard Drawing RCB-2.
17. Provide a quantity of solid sodding in the plans for use around flared end sections and box culvert headwalls as shown on Standard Drawings FES-1 and RCB-2, respectively.
18. Normally specify Type MO Drop Inlets unless Type C Drop Inlets are specifically needed.

SECTION 7

SUMMARY OF QUANTITIES

DATE: 09-12-14

The Summary of Quantities should generally include, but not be limited to, the following information:

1. Item number listed in numerical order as listed in the 2014 Standard Specifications plus any reference to a Special Provision or Supplemental Specification.
2. Item description as listed in the 2014 Standard Specifications, in a Special Provision, in a Supplemental Specification, or in the latest edition of the BAMS.
3. Total quantity of each item from the quantity boxes.
4. Totals as shown from Schedule of Bridge Quantities.
5. Separation of quantities for structures over 20'-0" (6.0m) span.
6. The following roadway quantities should be carried to two decimal places:
 - SUBGRADE PREPARATION
 - APPROACH SLABS AND GUTTERS
 - PORTLAND CEMENT CONCRETE DRIVEWAYS
 - MOBILIZATION
 - MAINTENANCE OF TRAFFIC
 - SEEDING
 - MULCH COVER
 - TEMPORARY SEEDING
 - OVERSEEDING SOD MULCH
 - SECOND SEEDING APPLICATION
 - ROADWAY CONSTRUCTION CONTROL
 - CLASS S CONCRETE-ROADWAY
7. The following roadway quantities should be carried to one decimal place:
 - WATER
 - PAVEMENT REPAIR OVER CULVERTS-CONCRETE
8. Roadway quantities not listed on the previous sections should be rounded to the nearest whole number.
9. Alternate bid items indicated by placing an asterisk (*) outside the quantity box next to the item with an alternate plus a note with the item description as follows: ALTERNATE NO.____.
10. Place a note below the quantity box explaining the asterisk (*) as follows:
 - *DENOTES ALTERNATE BID ITEMS.

SECTION 8

PLAN AND PROFILE SHEETS

DATE: 10-24-97

Plan and Profile Sheets should generally include, but not be limited to, the following information:

1. Show beginning and ending stations of project.
2. Show proposed centerline construction as well as proposed travel lanes.
3. Show existing topo.
4. Provide reference points, if applicable.
5. Provide all PI points and delta angles according to survey information.
6. Provide bearings along centerline construction.
7. Show north arrow and proposed centerline stationing.
8. Show bar scale for plan and profile scale for metric projects as well as metric logo in lower right corner.
9. Provide transition from existing conditions to proposed project at beginning and end of project.
10. Show travel lane and shoulder dimensions at beginning and end of project and at beginning and end of any travel lane addition or deletion and tapers thereto.
11. Dimension lengths for any tapers.
12. Show all proposed driveways and side streets. Show proposed driveway and side street widths. Provide construction notes for ALL driveways and side streets and include size and length for proposed side drains and earthwork for approaches. Do not call for equivalent diameters of any pipe culverts.
13. Show proposed cross drains and provide construction notes for each. Provide Class of R.C. Pipe, Type of Bedding for R.C. and C.M. Pipe Culvert installations, drainage areas and discharge for ALL cross drains. Replace all metal cross drains on arterials and freeways with R.C. pipes. Provide picture and flow line elevations in profile.
14. Show all drop inlets and storm drain pipe locations. Show picture of drop inlets and storm drains in profile. Provide top, flow line, and invert elevations for all drop inlets in profile as well as Class of R.C. Pipe, Type of Bedding required for R.C. and C.M. Pipe installations, lengths, and slopes of storm drain pipes.
15. Provide in the profile the beginning and ending stations and elevations of all ditch grades as well as side on which to be placed.
16. Provide pipe culvert alternates as per latest pipe culvert policy.
17. Provide existing and proposed bridge construction notes. Provide proposed bridge end stationing.
18. Show guardrail locations with picture and/or construction notes.
19. Place P.E. Stamp.

SECTION 8

PLAN AND PROFILE SHEETS

DATE: 12-30-96

20. Show placement of temporary erosion control devices if separate detail sheets are not utilized.
21. Show placement of proposed fence using "Bow-Tie" symbols.
22. Show construction limits of all roadways (main lanes, detours, etc.).
23. Show all existing and proposed right-of-way. Show all T.C.E. and P.C.E. requirements. Provide proposed stationing and distances from centerline construction for all proposed R/W, T.C.E.s, and P.C.E.s.
24. Provide curve data. Include superelevation rates and transition lengths with curve data. Provide station limits detailing beginning, end, and maximums for superelevation in profile.
25. Provide bench marks in profile.
26. Provide existing profile. Provide proposed grade line in profile along with lengths of vertical curve. Provide corrected and uncorrected PVI elevations. Provide profile grades for detour alignments.
27. Provide earthwork notes in profile if hauling excavation from one location to another.
28. If project includes several different sections, show name of section in plan view above profile grid on right side.
29. Show Limits of Floodplain, if applicable.
30. Show locations of Wheelchair Ramps on projects that include Curb and Gutter.
31. Wire Fence should be shown tying to R.C. Box Culvert wing walls for culverts that are 5' (1500mm) and higher.
32. Show beginnings and ends for Control of Access.
33. Provide base flood, overtopping, and frequency for bridge length R.C. Box Culverts. This information to be shown in Profile.
34. Provide design high water for bridges and show in Profile.
35. Elevations should be shown to 3 decimal places for Metric projects and should be shown to 2 decimal places for English projects.
36. Provide classification of stream (perennial or 5 cfs) and elevation of stream bank for each detour in project that crosses a waterway as specified in Section 110.06 of the Standard Specifications.

SECTION 9
CROSS SECTIONS

DATE: 10-24-97

Cross sections should generally include, but not be limited to, the following information:

1. Beginning and end stations of project and transitions.
2. Dimension taper widths when adding or deleting main lanes.
3. Existing and proposed centerline elevations on sections using profile grade. Existing centerline elevations on sections to be overlaid without using a profile grade.
4. Side slopes and cross slopes of all roadways in project. This includes stage construction and detours. Show placement of temporary precast concrete barrier, if needed, according to fill height requirements.
5. Proposed driveways and side drains with percentage of driveway slope used to tie to existing drive.
6. Proposed county road or street connections with side drains.
7. Cross drain culverts with flow line elevations and construction notes that include class of R.C. pipe and type of bedding for R.C. and C.M. pipe culvert installations.
8. Drop inlets and storm drain with flow line elevations. (Construction notes not necessary for drop inlets or storm drains.)
9. Superelevation rates and/or pavement edge elevations in superelevated sections for all designed roadways. (Includes detours and stage construction.) Check and correct computer annotations not shown the way we compute superelevation.
10. Areas and volumes separated for all stages of earthwork. Do not include 10% in volumes for compacted embankment.
11. Annotate cross sections and centerlines of stage construction.
12. Correct subgrade lines in superelevation so they are shown according to current policy. Subgrade should be parallel to finished grade on low side of super and shall break back on $-0.02'/'$ (2%) at edge of travel lane on high side.
13. Annotate and widen cross section where guardrail is to be placed.
14. Show elevations under ditches where ditch grades are utilized.
15. Dimension beginning and ends of tapers for lane widening.
16. Metric logo in lower right corner for metric projects.
17. P.E. stamp not required.

APPENDIX

APPENDIX A

PAVEMENT DESIGN CRITERIA

DATE: 05-01-98

1. A pavement design analysis should be completed on all projects using the latest AASHTO design guidelines.
2. An approved copy of the pavement design should be sent to the following:
 - a) Master "B" File in Construction Division.
 - b) FHWA for all federal oversight projects.
3. In accordance with Paul DeBusk's memo dated March 18, 1992, the minimum typical section for collectors and local roads should be as follows:

Current ADT	0 – 250	28' DAST & 7" Aggregate Base
	< 10% Trucks	

Current ADT	> 250	28' 220 Lbs/Sq. Yd. ACHM Surface Course & 9" Aggregate Base
-------------	-------	---

4. The following values should be used for Coefficients of relative strength:

ACHM Surface Course (3/8", 9.5mm, 1/2", 12.5mm)-----	0.44
ACHM Binder Course (1", 25mm)-----	0.44
ACHM Base Course (1-1/2", 37.5mm) -----	0.36
P. C. Stabilized Base (Soil Cement) -----	0.20
Aggregate Base Course (Class 7) -----	0.14
Aggregate Base Course (Class 5) -----	0.11
Lime Treated Subgrade-----	0.07
5. The correlation of the R-Value and the Resilient Modulus should be made using the "Correlation Chart for Estimating Resilient Modulus" shown on Page A-5.
6. Reliabilities used for the specified type of roadway should be as follows:

Interstate	-	90 – 95%
Primary	-	85 – 90%
Secondary	-	75 – 80%
Urban	-	80 – 95%
7. Pavement Designs for two lane roadways shall use the following format when calculating the design traffic for 20 year projections:
ESALS x 0.5 x 20 x 365
8. Pavement Designs for four lane roadways shall use the following format when calculating the design traffic for 20 year projections:
ESALS x 0.5 x 0.8 x 20 x 365
9. Initial Serviceability should be 4.5 and Terminal Serviceability should be 2.5. Standard deviation should be 0.45 for flexible designs and 0.35 for rigid designs.
10. Prime Coat should not be used except when using Asphalt Surface Treatment.
11. In accordance with Robert L. Walters' memo dated December 2, 1992, the following practices should be used in the design of flexible pavements:
 - a) If locally available subgrade material does not provide desired stability characteristics, either import better material or treat the on-site material.
 - b) The binder course should not be placed directly on the subgrade.

APPENDIX A

PAVEMENT DESIGN CRITERIA

DATE: 05-10-06

12. On the main lanes for all freeways and principle arterial routes, extend full depth pavement structure 2 foot into each shoulder for two-way routes and into the outside shoulder for one-way routes.
13. If a non-permeable base is considered for use on the shoulders, an economic analysis should be made to determine the most economical alternative (non-permeable base with underdrains or permeable base).
14. All pavement designs should include at least 3 alternates with an economic analysis for each alternate. High volume projects on new location should include alternates for flexible and rigid pavement.
15. In accordance with Jim Gee's memo dated September 6, 2000, the following criteria should be used for the selection of Performance Grade Asphalt Binder for asphalt concrete hot mix projects:

Design ESAL's (Millions)	*Performance Grade Binder
<3.0	64-22
3.0 to 30.0	70-22
>30.0 & Interstate	76-22

*For Urban areas with slow moving and/or stopping traffic and for rural **arterial** intersections with stopping traffic, increase the Performance Grade **ONLY** for ACHM Surface Course as follows:

- NORTH of Interstate 40:** Use one level higher grade with 76-22 being maximum grade.
- SOUTH of Interstate 40:** Use two levels higher grade with 76-22 being maximum grade.

Use a minimum of 1000 tons of asphalt mix when specifying PG 70-22 or PG 76-22. When using higher performance grade asphalt in an urban area, use 4" of ACHM Surface Course where feasible. When specifying PG 70-22 or PG 76-22, use PG 64-22 for driveways and minor roadway approaches.

16. The maximum number of gyrations (Nmax) used with Superpave Asphalts shall be in accordance with the following table:

<u>DESIGN ESALS (millions)</u>	<u>Nmax</u>
<3.0	115
3.0-30.0	160
>30.0	205

17. In accordance with the March 23, 1998, Pavement Selection QIP Team's recommendations, the following procedures should be followed in developing pavement designs for flexible pavements:

PAVEMENT DESIGN PROCEDURE

The pavement selection procedure eliminates the Pavement Design Review Committee's review for each individual project. The procedure allows the designer to prepare the pavement design based on pavement selection criteria developed by the Committee.

APPENDIX A

PAVEMENT DESIGN CRITERIA

DATE: 05-10-06

The pavement selection criteria for flexible pavements are shown in Table 3 for major collector routes and above. This table is to be used for new construction and widening only. It does not apply to overlays. An Interstate rehabilitation procedure is not shown because of its complexity. The table reflects the views of the QIP Team regarding the use of design alternatives. This table is recommended for use by designers when considering alternatives. However, it should be realized that this table does not include all design alternates available to the designer. Options, such as the use of cement stabilized base, soil stabilization, and subbases are not listed explicitly in the table. Furthermore, if economics or other considerations cause a deviation from these criteria, the reasoning should be documented and approval obtained from the Roadway Design Engineer.

The proposed pavement design procedure is presented in Table 3. The procedure eliminates the need for the Pavement Design Review Committee to meet on a regular basis. The Assistant Chief Engineer for Design may call on the Pavement Design Review Committee to meet to discuss general issues regarding pavement selection, revisions to the Pavement Selection Criteria, or particular designs as needed.

TABLE 3

Aggregate Base Thickness (in)		**ACHM Base Thickness (in)		*ACHM Binder Thickness (in)		ACHM Surface Thickness (in)		Total Thickness (in)	
Min	Max	Min	Max	Min	Max	Min ¹	Max	Min ²	Max
6	12	4	12	3	6	2	4	12	N/A

¹ 9.5 mm asphalt mixes may be placed in 1.5 inch lifts to a maximum of 3 inches.

² The minimum total thickness will not apply for low volume roads.

* ACHM Binder would be limited to design thickness of 3", 3.5", 4", 4.5", or 6".

**ACHM Base would be limited to design thicknesses of 4", 4.5", 5", 8", 8.5", 9", 9.5", 10", or 12".

Pavement Design Procedure

- The designer gathers all needed information such as traffic, equivalent axle loads, soil strength, and deflection data needed to design the pavement.
- The designer designs the pavement according to AASHTO and within the parameters established by the Roadway Design Division.
- The designer consults with District personnel concerning preferences and needs as it pertains to pavement selection.
- The designer selects three (3) alternatives for a detailed design and cost analysis. Generally, one of the three alternatives is a full depth asphalt pavement design with the other two alternatives consisting of a stone base with asphalt surfacing. All of the alternatives should meet the Flexible Pavement Design Criteria.
- If any of the design alternatives do not meet the Flexible Pavement Design Criteria, the alternative should include a note to that effect and a brief explanation of the reasons for using a special design alternative.
- The designer submits these three alternates complete with cost estimates to the Roadway Design Engineer for review.
- The Roadway Design Engineer selects the appropriate alternative and submits the recommended alternative to the Assistant Chief Engineer for Design for approval.

APPENDIX A

PAVEMENT DESIGN CRITERIA

DATE: 05-30-19

Suggested Minimum Pavement Design: Stone Base Alternative

ACHM Surface Course (1/2") 4"
ACHM Binder Course (1") 3"
Aggregate Base Course (Class 7) 6"

Provides SN = 3.92

Criteria for use:

Based on the R-Value for a given project the follow table gives the Maximum number of ESALS allowable for the suggested minimum pavement design.

R-Value	Arterials	Collectors
	Max. ESALS	
5	290,000	355,000
6	310,000	385,000
7	340,000	415,000
8	365,000	450,000
9	400,000	485,000
10	430,000	530,000
11	465,000	570,000
12	505,000	620,000
13	550,000	670,000
14	595,000	725,000
15	645,000	785,000
16	695,000	855,000
17	755,000	925,000
18	815,000	1,000,000
19	885,000	1,085,000
20	955,000	1,175,000

Note: These ESALS are based off the Reliabilities of 85% for Arterials and 80% for Collectors.

Pavement designs should be evaluated on a site by site basis. This is meant only as a suggestion based off design standards.

APPENDIX A

PAVEMENT DESIGN CRITERIA

DATE: 05-30-19

Suggested Minimum Pavement Design: Full Depth Asphalt Alternative

ACHM Surface Course (1/2") 4"
ACHM Binder Course (1") 3"
ACHM Base Course (1-1/2") 5"

Provides SN = 4.88

Criteria for use:

Based on the R-Value for a given project the follow table gives the Maximum number of ESALS allowable for the suggested minimum pavement design.

R-Value	Arterials	Collectors
	Max. ESALS	
5	1,330,000	1,630,000
6	1,440,000	1,765,000
7	1,560,000	1,910,000
8	1,690,000	2,070,000
9	1,830,000	2,240,000
10	1,980,000	2,425,000
11	2,145,000	2,625,000
12	2,325,000	2,845,000
13	2,520,000	3,080,000
14	2,725,000	3,335,000
15	2,955,000	3,615,000
16	3,200,000	3,915,000
17	3,465,000	4,240,000
18	3,755,000	4,595,000
19	4,065,000	4,975,000
20	4,400,000	5,385,000

Note: These ESALS are based off the Reliabilities of 85% for Arterials and 80% for Collectors.

Pavement designs should be evaluated on a site by site basis. This is meant only as a suggestion based off design standards.

APPENDIX B

CLEAR ZONE REQUIREMENTS

DATE: 12-30-96

1. Clear zones shall be the same distance on both sides of the proposed roadway and shall be measured from the outside edge of the outermost lane. The desired width is dependent upon the traffic volumes, speeds, and slopes.
2. Clear zone widths shall be designed on all projects using the latest edition of the AASHTO Roadside Design Guide in combination with the design criteria of the specific projects.
3. Roadways classified as rural collectors and designed less than or equal to 40 mph shall use a minimum clear zone distance of 10 feet.
4. Roadways using a curb and gutter design shall use a minimum clear zone of 1.5 feet behind curb.
5. Ditch backslopes, side drains, and ends of cross drains shall be located outside the clear zone dimension.
6. Where ditches are to be located within the proposed clear zone, the ditch cross section will conform to the preferred ditch cross section detailed in the AASHTO Roadside Design Guide.
7. All side drains and cross drains located within the clear zone distance shall use special end treatments.
8. In accordance with Robert L. Walters' memo dated March 13, 1987, clear zones should be provided on interchange ramps. This clear zone should be 30' on both sides of the ramp, and side slopes should preferably be 6:1 but no steeper than 4:1.
9. When using the Clear Zone Distance Table in the AASHTO Roadside Design Guide, use the distance given under the "Fill Slopes", unless project is a "3R" project. For "3R" projects, use the "Fill Slopes" table for fill slopes and the "Cut Slopes" table for cut slopes. This allows the designer to use lesser clear zones on the cut side in order to minimize proposed right of way requirements.

APPENDIX C

ACCESS CONTROL DESIGN CRITERIA

DATE: 12-07-17

1. In accordance with the Minute Order 2017-112 passed in December 6, 2017, the following guidelines are to serve as the Department's access control policy:

I. ACCESS CONTROL

A. FULL CONTROL

- Access allowed at interchanges only.

B. PARTIAL CONTROL

1. Two Lane Facilities

- At-grade access allowed at selected intersecting public roads/streets.
- Each abutting property ownership to have access based on amount of frontage, as follows:
 - ✓ Less than 1200 feet frontage – 1 access
 - ✓ 1200 feet or more frontage – 1 access for each FULL 600 feet of frontage
 - ✓ Criteria apply to each side of highway when highway divides a parcel.

2. Four Lane Divided Facilities

a. High Type Control

- At-grade access provided at selected intersecting public roads/streets.
- No direct private access permitted.

b. Low Type Control

- Access control provided as set out for "Two Lane Facilities".

3. Others

- As established by Arkansas Highway Commission.
- Access control is within the discretion of the Arkansas Department of Transportation, with consideration given to the design, safety, location, and terrain of the specific facility.

II. MEDIAN OPENING SPACING

A. RURAL

- Openings to be spaced generally at ½ mile intervals.

B. SUBURBAN/URBAN

- Openings may be spaced generally at ¼ mile intervals.

In determining median opening locations, terrain, local service needs, and location of major public roads will be considered.

APPENDIX C

ACCESS CONTROL DESIGN CRITERIA

DATE: 12-07-17

2. In accordance with Robert L. Walters' memo dated September 1, 1992, the policy of the ARDOT concerning County Road, City Street, and Private Driveway Turnouts on construction projects shall be as follows:
 - **ARTERIALS:** Turnouts shall be paved to the right of way. Where turnout construction must extend beyond the normal right of way, paving shall be carried to the end of the turnout construction.
 - **COLLECTORS AND LOCALS:** Turnouts shall be surfaced with materials similar to those existing. As a minimum, the area within the entrance radii shall be paved to prevent aggregate from being scattered onto the roadway. Where the existing turnout is aggregate, sufficient aggregate shall be placed between the paved turnout or approach and the construction limits to provide surfacing at least equal to that existing.
 - Where turnout construction extends beyond the normal right of way, appropriate construction easements (temporary or permanent) shall be obtained to accommodate the turnout construction.

APPENDIX D

CULVERT SELECTION CRITERIA

DATE: 11-07-19

- In accordance with Phil McConnell's memo dated October 19, 2010, the pipe culvert policy is as follows:

<u>Type Facility</u>	<u>Pipe Function</u>	<u>Material Type</u>
Interstate (Fully Controlled Access)	Cross Drain	Concrete
	Storm Sewer	Concrete
Arterial	Cross Drain	Concrete
	Storm Sewer	Concrete or Smooth Lined Polymer Coated CSP
Collector and Local	Cross Drain	Concrete or Asphalt Coated CSP or Aluminum Coated CSP or Polymer Coated CSP or *High Density Polyethylene (HDPE) or *Polyvinyl Chloride (PVC) *Polypropylene (PPL)
	Storm Sewer	Concrete or Smooth Lined Polymer Coated CSP or *High Density Polyethylene (HDPE) or *Polyvinyl Chloride (PVC) *Polypropylene (PPL)
All	Side Drain	Refer to Section 606 of the current Standard Specifications

*Polyethylene Pipe ranging in diameter from 18" min. – 48" max.

*PVC Pipe ranging in diameter from 18" min. – 36" max.

*Polypropylene Pipe ranging in diameter from 18" min. – 60" max.

- The design of all drainage structures shall be in accordance with the "Summary of Recommended Criteria for Design Frequency" shown on Page D-3.

APPENDIX D

CULVERT SELECTION CRITERIA

DATE: 11-07-19

PIPE SELECTION
FLOW CHART

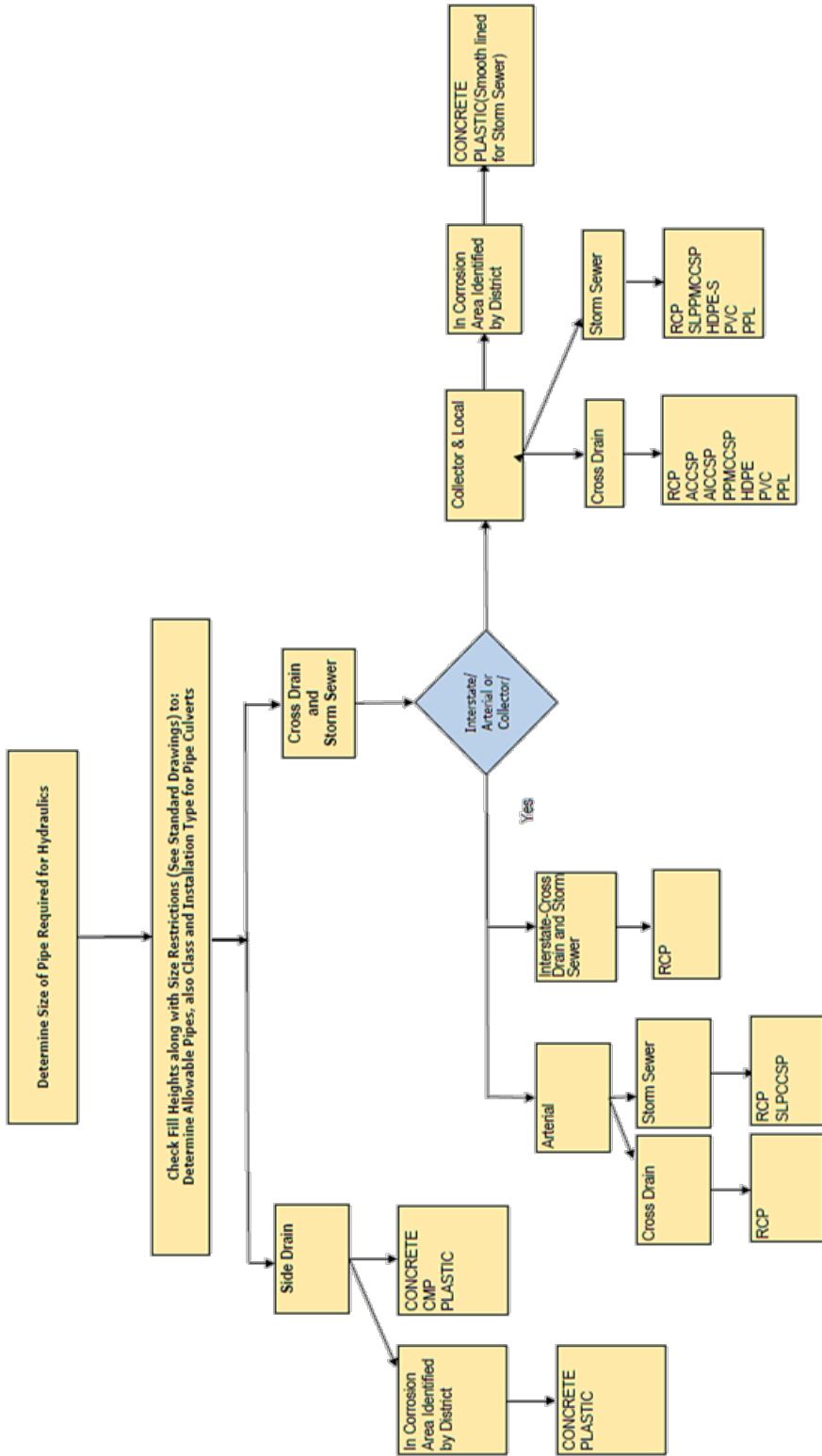

CONCRETE	Reinforced Concrete Pipe
CMP	Zinc Coated Corrugated Steel Pipe
RCP	Aluminum Coated Corrugated Steel Pipe
ZCCSP	Aluminum-Zinc Alloy Coated Corrugated Steel Pipe
AICCSP	Corrugated Aluminum Pipe
AIZCCSP	Asphalt Coated Corrugated Aluminum Pipe
CAP	Polymer Precoated Metallic Coated Corrugated Steel Pipe
ACCSP	Smooth Lined Polymer Precoated Metallic Coated Steel Pipe
ACCAP	High Density Polyethylene Pipe
PPMCCSP	High Density Polyethylene-Type S Plastic Pipe
SLPPMCCSP	Polyvinyl Chloride Pipe
PLASTIC	Polypropylene Pipe
HDPE	
HDPE-S	
PVC	
PPL	

APPENDIX D

CULVERT SELECTION CRITERIA

DATE: 01-01-11

SUMMARY OF RECOMMENDED CRITERIA FOR DESIGN FREQUENCY

The following flood frequency values relative to protection of the roadway from flooding or damage are recommended for design:

	<u>Cross Drains</u>	<u>Storm Drains² Side Drains and Pavement Drainage</u>	<u>Design Spread³</u>
Interstate Projects	50-year	50-year	½ outer driving lane
Principal Arterials	50-year	10-year	outer driving lane
Minor Arterials	50-year	10-year	outer driving lane
Major Collectors	25-year	10-year	outer driving lane
Minor Collectors	25-year	10-year	outer driving lane
Local Highways	10-year ¹	2-year	outer driving lane

¹Drainage area less than 520 hectares (two square miles) and ADT less than 750. If either is exceeded, use 25-year flood frequency.

²If a storm drain or side drain provides the inlet and outlet for a cross drain then the design frequency of the cross drain shall be used for that segment of the drainage system.

³For three or more lanes. If a two lane facility is being designed, spread shall not exceed ½ of the driving lane.

One or more of the following allowable headwater values relative to protection of the roadway from flooding are recommended for design:

Design Flood

- non-damaging to adjacent property,
- 0.3 m (1 foot) below the lowest shoulder edge, and
- $HW/D \leq 1.5$.

Review Flood (100-year)

- does not exceed the existing 100-year flood elevation as provided by the National Flood Insurance Program (NFIP) mapped floodways or in the vicinity of insurable buildings,
- does not exceed 0.3 m (1 foot) increase over the existing 100-year flood elevation in the NFIP mapped floodplains or in the vicinity of insurable buildings, and
- has a level of inundation on upstream property and the roadway for the 100-year discharge which is in accordance to the Department's design practice.

APPENDIX E
GUARDRAIL CRITERIA

DATE: 09-05-18

1. In accordance with Robert L. Walters' letter to FHWA dated April 10, 1992, the following is the Department's policy on guardrail end terminals:
 - a) NHS – Turned-down ends will not be used; alternative treatments will be provided.
 - b) Non-NHS – Where design speeds are 50 mph or more and ADT exceeds 6000 vpd, turned-down ends will not be used. Where design speeds are less than 50 mph, regardless of ADT, turned-down ends will continue to be an acceptable end treatment.
2. Alternative guardrail end terminals shall conform to the latest version of MASH.
3. Length of guardrail should be as shown on Standard Drawing GR-9 unless requirements for length of need are greater.

APPENDIX F

TRAFFIC CONTROL CRITERIA

DATE: 07-25-19

1. A traffic control plan should be developed for each project. The details of the traffic control plan should be commensurate with the complexity of the project.
2. In accordance with Robert L. Walters' memos that are dated August 14, 1987 and May 1, 1990, the following is the Department's detour design criteria:
 - A. Detour design speed should normally be 10 mph less than posted speed.
 - B. Pavement widths should be 20 feet minimum. Match existing roadway widths if greater than 20 feet.
 - C. Shoulder width should be 2 feet minimum.
 - D. Detour surface, including shoulders, should be paved unless existing road is unpaved.
3. In accordance with Robert L. Walters' memo dated May 3, 1993, the following criteria should be used for low volume or high volume classification:

Low Volume – current ADT of 2000 vpd or less.

High Volume – greater than current ADT of 2000 vpd.
4. The placement of final pavement markings shall be according to the "Pavement Marking Material Selection Guidelines for New Pavements" shown on Page F-3.
5. As per 23 CFR 630 Subpart K, the use of positive protection devices on a project includes the consideration and management of both (a) the road user and (b) worker safety. The following should guide design and construction decisions regarding the use of positive protection devices (mainly temporary concrete barrier wall):

Road User Safety

- (a) Refer to Standard Drawing TC-3 for the traffic control devices for vertical pavement differentials and temporary slopes.
- (b) The traffic control devices tables shall be used in conjunction with Standard Drawings TC-3, TC-4, and TC-5.

Worker Safety

- (a) Accordingly, appropriate consideration of worker exposure to traffic needs to be considered to determine the need for positive protection devices. The following factors and characteristics should be considered during plan development and documented through the Transportation Management Plan process:
 - Roadway classification.
 - Scope and duration of the project.
 - Phasing of the project.
 - Anticipated traffic speeds through the work zone.

APPENDIX F

TRAFFIC CONTROL CRITERIA

DATE: 07-25-19

- Anticipated traffic volumes and Vehicle Mix through the work zone.
- Type of work.
- Distance between traffic and works, and extent of worker exposure.
- Escape paths available for workers to avoid a vehicle intrusion into the work space.
- Time of day (e.g., night work).
- Work area restrictions.
- Potential hazard to workers and road users presented by device itself and during device placement and removal.
- Geometrics that may increase crash risks.
- Impacts on project cost and duration.
- Safe entry/exit of work vehicles onto/from the travel lanes.
- Consequences from/to road users resulting from roadway departure.

APPENDIX F

TRAFFIC CONTROL CRITERIA

DATE: 10-25-18

ARKANSAS DEPARTMENT OF TRANSPORTATION

PAVEMENT MARKING MATERIAL SELECTION GUIDELINES FOR NEW PAVEMENTS

<u>FREEWAY - (MAIN LANES, RAMPS, & CD ROADS)</u>	
SKIP	ENHANCED THERMOPLASTIC PAVEMENT MARKING
EDGE	ENHANCED THERMOPLASTIC PAVEMENT MARKING
TRANSVERSE	THERMO/TAPE
MISC	THERMO/TAPE
<u>NON-FREEWAY - (MULTI-LANE)</u>	
CENTER	THERMO
SKIP	THERMO
EDGE	THERMO
TRANSVERSE	THERMO/TAPE
MISC	THERMO/TAPE
<u>ADT > 2000 - (2-LANE)</u>	
CENTER	THERMO
SKIP	THERMO
EDGE	THERMO
TRANSVERSE	THERMO/TAPE
MISC	PAINT/THERMO
<u>ADT < 2000 - (2-LANE)</u>	
CENTER	PAINT
SKIP	PAINT
EDGE	PAINT
TRANSVERSE	PAINT
MISC	PAINT

Miscellaneous Markings include messages, arrows, railroad, etc.
 Transverse Markings include shoulder, stop lines, crosswalks, etc.

APPENDIX G

PLAN REVIEW AND COORDINATION

DATE: 12-30-96

1. A preliminary and final plan review should be held with appropriate personnel for each project. The preliminary review should normally be made when the plans are 40% - 50% complete. The final review should normally be made when the plans are 90% - 100% complete.
2. In accordance with the Chief Engineer's memo dated September 15, 1987, the plans for selected projects should be transmitted to Materials Division for a Geotechnical Design review.
3. In accordance with the Chief Engineer's memo dated September 11, 1990, public access to major rivers in the State should be coordinated with the Game and Fish Commission. The procedure should be as follows:
 - A. When preliminary plans are developed to the initial field inspection stage, Roadway Design will contact the Game and Fish Commission. The purpose of this contact is to:
 - a) have Game and Fish determine the need for public access at the project location, and
 - b) set up a site inspection with Game and Fish if they so desire.
 - B. If the Game and Fish Commission determines that no public access is needed, a memorandum documenting this decision will be included in the files and design will proceed without further Game and Fish involvement.
 - C. If the Game and Fish Commission determines public access to be desirable, design will coordinate the location and size of such access area with the Game and Fish Commission.
 - D. A memorandum will be submitted to the Assistant Chief Engineer-Design for concurrence when one or both of the following conditions are involved:
 - a) parking area exceeding one (1) acre in size, or
 - b) additional right of way (beyond normal project limits) is needed to accommodate the access area. (Additional right of way for public access will be the responsibility of the Game and Fish Commission.)
 - E. The Game and Fish Commission will provide drawings and specifications needed for boat launching ramp facilities; construction will be a contract item.
 - F. Quantities for the access construction shall be separated out in the plans in order to handle various funding schemes.

APPENDIX H
DESIGN CHECKLIST

DATE: 05-01-98

JOB _____

PRELIMINARY DESIGN

1. Do PPC and Green Book agree? _____
2. Do geometrics meet design speed? _____
3. Clear Zone provided? _____
4. Width of Surfacing and Bridges consistent with AASHTO? _____
5. Grades above high water? _____
6. Fence handled per policy? _____
7. Detours required? _____
8. Stage construction necessary? _____
9. Geotechnical recommendations received? _____
10. Does Title Sheet have (F) or (S)? _____
11. Does Typical agree with Pavement Design? _____
12. If Drainage District involved, has Hydraulics handled? _____
13. If waivers required, have they been documented? _____
14. Preliminary Prints sent to Railroad Coordinator? _____
15. Sepias sent to Right of Way and Environmental? _____
16. Preliminary Field Inspection? _____
17. Classification of Stream and Elevation of Stream Bank shown for detour? _____

FINAL DESIGN

1. Geotechnical recommendations incorporated?
If not, are reasons documented? _____
2. Hydraulic considerations handled? _____
3. Items in environmental document included? _____
4. Nmax shown under all quantity boxes that contain asphalt? _____
5. Floodplain boundaries shown? _____
6. Drainage districts notified if involved? _____
7. Materials availability requested? _____
8. Alternates for lime stabilization included? _____
9. Sidewalks handled per policy? _____
10. Wheelchair Ramps provided? _____
11. Undercut areas noted? _____
12. Survey control sheets included as per Surveys' latest memo? _____
13. Traffic control plan included? _____
14. Sequence of Construction outlined? _____
15. Pavement marking removal included? _____
16. "Do Not Pass" signs included? _____
17. Any items paid as plan quantity? _____
18. FHWA comments included?
If not, are reasons documented? _____
19. Patching repair for pavement cuts for pipes necessary? _____
20. Channel excavation provided at culverts? _____
21. Channel excavation at bridges included in quantities? _____
22. Aggregate for temporary drive access? _____
23. Asphalt for patching existing road or detour? _____
24. Right of Way considerations included and handled? _____

APPENDIX H
DESIGN CHECKLIST

DATE: 05-01-98

- 25. Asphalt percentage obtained from Materials? _____
- 26. Class of R.C. pipe and type of bedding checked including storm drains? _____
- 27. Class of R.C. pipe and type of bedding for all pipes included in notes? _____
- 28. Selected pipe bedding and backfill included? _____
- 29. Superelevation rates, transitions, and station limits shown on plans? _____
- 30. Working day estimate discussed with District? _____
- 31. Final Field Inspection? _____

FINAL CHECK

- 1. Correct specifications included for special items? _____
- 2. Maintenance of Traffic and Mobilization in Summary? _____
- 3. Leveling quantities provided? _____
- 4. All quantities carried to summary? _____
- 5. Rough check of quantities? _____
- 6. Copy of Final Field Inspection Report to Programs and Contracts? _____
- 7. PE stamp included on all roadway sheets? _____
- 8. Metric logo shown on each sheet? _____
- 9. Metric scale shown on each plan and profile sheet? _____
- 10. Engineer's Estimate reviewed and signed by Section Head? _____

Design Engineer

Date

APPENDIX I

CONSULTANT PLAN SUBMITTALS

DATE: 08-01-02

1. Consultant Engineering Firms hired directly by the Department for the purpose of plan preparation shall make a minimum of three (3) plan submittals to the Department.
 - a) 30% Submittal
 - i) This submittal should include, but not be limited to, the following information:
 - Title Sheet with design data, correct job title and number, sketch map, vicinity map, and district map.
 - Typical Sections of Improvement.
 - Geometric design (horizontal and vertical alignment) of all roadways in project. Submit all interchange layouts, if applicable to project.
 - b) 60% Submittal
 - i) This submittal should include, but not be limited to, the following information:
 - All information contained within the 30% submittal.
 - Typical Sections of Improvement detailing lane and shoulder widths complete with widths and rates of the individual paving components.
 - Maintenance of Traffic preliminary plan details.
 - Erosion Control details.
 - Special Details needed for project.
 - Plan and Profile sheets with all drainage design, right of way requirements, construction limits, and frontage roads (if applicable).
 - Survey Control detail sheets.
 - Cross Sections.
 - This submittal should contain virtually everything except for the quantities.
 - c) 90% Submittal
 - i) This submittal should include everything included in the first two submittals along with the quantities, index with list of special provisions and general notes, summary of quantities and revisions, and the special provisions written for the project.
 - ii) This submittal should also include the final Maintenance of Traffic details, all bench mark stations and locations detailed on the plan and profile sheets, and any floodplain limits (if applicable to the project) shown on the plan and profile sheets.
 - iii) This submittal should not be made before final corrections have been made to the right of way plans and after the right of way plans have been correlated to the construction plans.
2. The final submittal should be a full size complete, signed, and sealed set of plans on reproducible paper.

APPENDIX J

INTERCHANGE LOOP RAMPS AND ACCELERATION LANES

DATE: 07-23-07

In an effort to provide guidance for designers where loop ramps are being designed, please refer to the following detail shown on Page J-2. This detail illustrates how to correctly lay out an interchange and apply superelevation where loop ramps are being utilized as exit ramps with a decel lane. This detail illustrates a situation where the main lanes curve to the left and the loop ramp curves to the right.

The detail shown on Page J-3 has been added to illustrate how to correctly apply the superelevation for entrance ramps where the entrance ramp is in a right curve and the main lanes are in a left curve.

APPENDIX J

INTERCHANGE LOOP RAMPS AND ACCELERATION LANES

DATE: 07-30-07

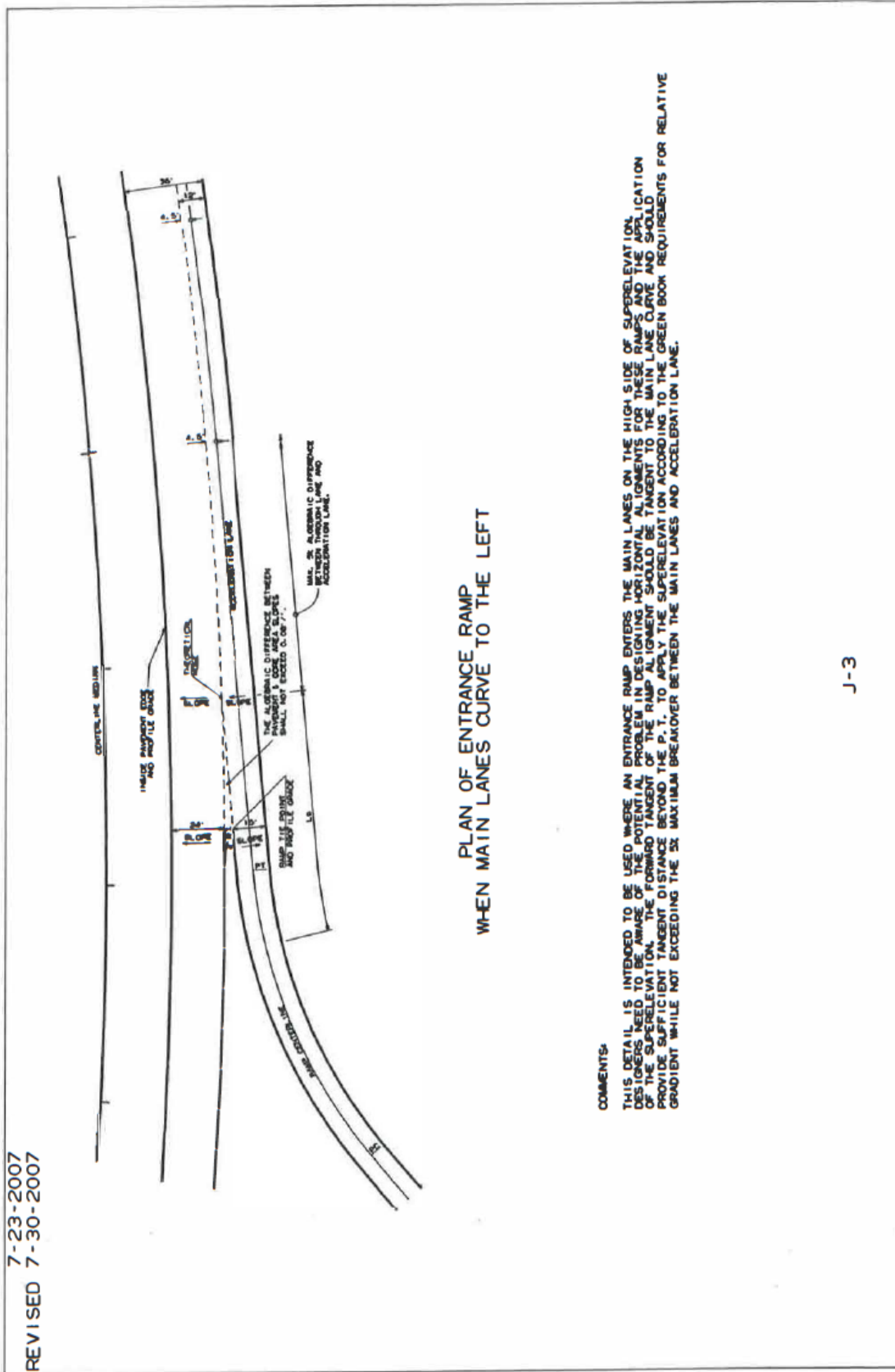

PLAN OF ENTRANCE RAMP
WHEN MAIN LANES CURVE TO THE LEFT

J-3

EXIT AND ENTRANCE RAMP WHEN ML'S CURVE TO LEFT Rev.dgn 07/27/2007 01:27:43 pm

APPENDIX K

GUIDELINES FOR PASSING LANE DESIGN

DATE: 10-25-18

1. Passing Lanes are to be designed with 3R Design Criteria for the horizontal and vertical controls only, unless otherwise specified, and modified 3R Design Criteria for Clear Zones, as explained below in item 4. Travel Lane and Shoulder widths should follow AASHTO criteria, unless 3R criteria is specified for lane and shoulder widths.
2. Lane widths for passing lanes should be a minimum 12'-0".
3. Shoulders on passing lane side should be a minimum 6'-0". Shoulders on lane opposite passing lanes should be minimum 8'-0".
4. Foreslopes on both sides of the roadway should be either 4:1 or 6:1 with clear zones designed as follows:
 - A. If R/W or relocatees are a problem, a minimum 10' Clear Zone can be used, as established by 3R Design Criteria, with the approval of the Division Head.
 - B. Clear Zones for Passing Lanes where the average running speed is 55 mph are generally designed with 24' in "Fill Sections" and 16' in "Cut Sections". These values are found in the AASHTO Roadside Design Guide for 55 mph, ADT 1500-6000, 4:1 Slopes.
 - C. Clear Zones for Passing Lane projects where the average running speeds are less than 55 mph should be set by the AASHTO Roadside Design Guide for "Cut" and "Fill" Sections as explained in 4B.
5. Lane additions tapers to introduce passing lanes should be 200' min. to 0.5L max. (MUTCD 6C.08)
6. Tapers to drop passing lane should be designed according to the formula $L=WS$.
 L =length of taper; W =width of passing lane; S =design speed (MUTCD 6C.08).
7. Passing lanes should be located in sparsely populated areas where proposed right of way requirements will not involve relocatees.
8. Passing lanes should be a minimum of one mile (5280') in length, excluding taper lengths.
9. Passing lanes should be located such that they do not involve any bridge construction. In other words, there should not be any bridges within passing lane locations (AASHTO Green Book Section 3.4.4).
10. There could be locations where passing lanes are added on both sides of the centerline to provide a 4-lane roadway.

APPENDIX K

GUIDELINES FOR PASSING LANE DESIGN

DATE: 10-25-18

11. Passing lanes that are constructed such that the existing centerline has to be relocated creating opposing passing lanes that line up on each other should be separated by tapers and a minimum 500' buffer.
12. If passing lanes are to be designed with 3R Design Criteria, instead of the modified 3R Design Criteria explained above, and the opposite lane and shoulder widths are correct, and the opposite foreslope has a minimum 3:1 foreslope with a minimum 10' clear zone to all obstructions, no work shall be done on the side opposite the passing lane except for an overlay of the existing lanes, shoulders and driveways.
13. The existing alignment may be shifted either 1 or 2 feet to the passing lane side to retain the opposite lane edge so that the widening of the travel lanes can be constructed on one side only.
14. If passing lanes are designed with 3R Design Criteria, instead of the modified 3R Design Criteria as explained above, and the opposite side needs to be reconstructed because of insufficient shoulder widths, foreslopes, or clear zones, that side shall be reconstructed using the same criteria for foreslopes and clear zones as is used on the passing lane side.
15. If using 3R Design Criteria to design passing lanes, superelevation values for cross slopes shall be according to Standard Drawing SE-2. The additional 20% increase for 3 lanes shown on SE-2 should not be applied on the passing lane projects. If an existing horizontal curve is being retained that is within 15 mph of the average running speed, that curve shall be "supered" according to the requirements of the average running speed. However, if the curve to be retained is "too sharp" to be listed under the average running speed column for superelevation, that curve shall be supered for the highest design speed under which that curve is shown.
16. If using 3R Design Criteria to design passing lanes, any horizontal or vertical curve that does not meet 3R Design Criteria shall be reconstructed according to AASHTO Design Criteria for the average running speed, including superelevation. Foreslopes, clear zones, lane widths, and shoulder widths will use the same design criteria for the off side as is used for the passing lane side.
17. Pipes on the passing lane side should extend to the "FILL" clear zone. Pipes on the off side should extend to the minimum clear zone (10'). This is true even if a new cross drain is being constructed across the entire roadway.